

3#齿轮箱减速电机技术参数

■ 卧式 Horizontal

■ 立式 Vertical

(3-PHASE MOTOR)

(1-PHASE MOTOR)

■ 卧式 Horizontal

■ 卧式 Horizontal

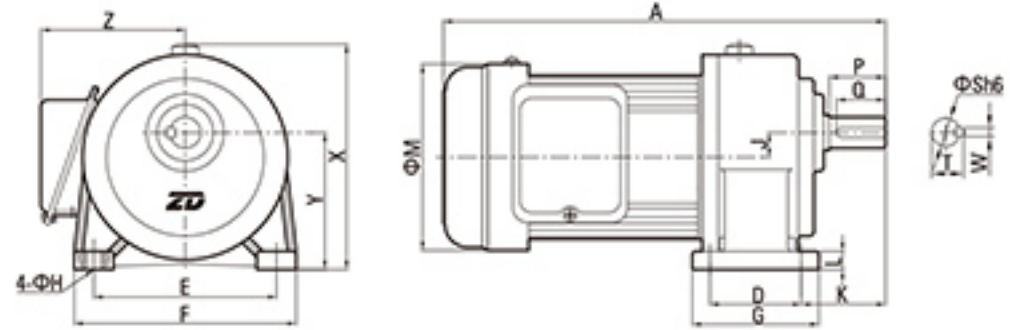
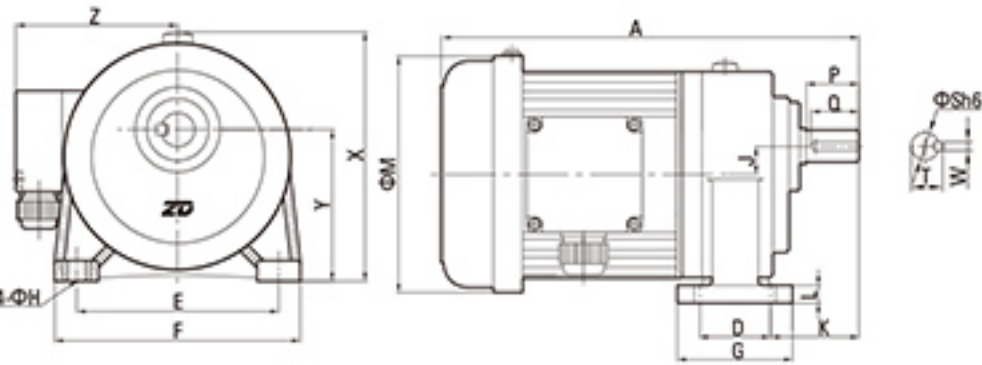

■ 立式 Vertical

■ 立式 Vertical

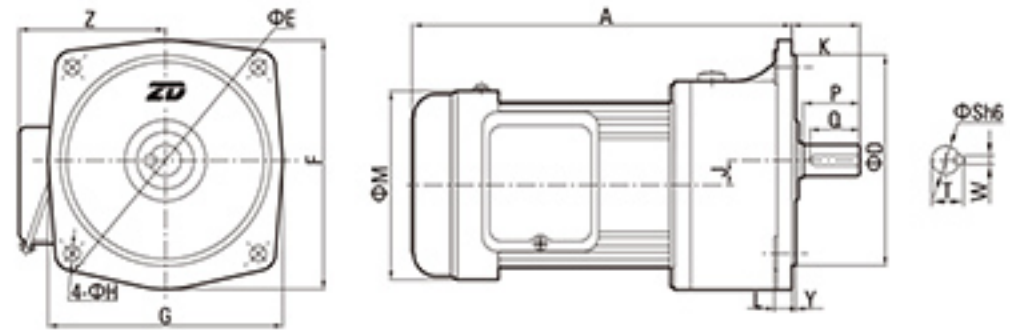
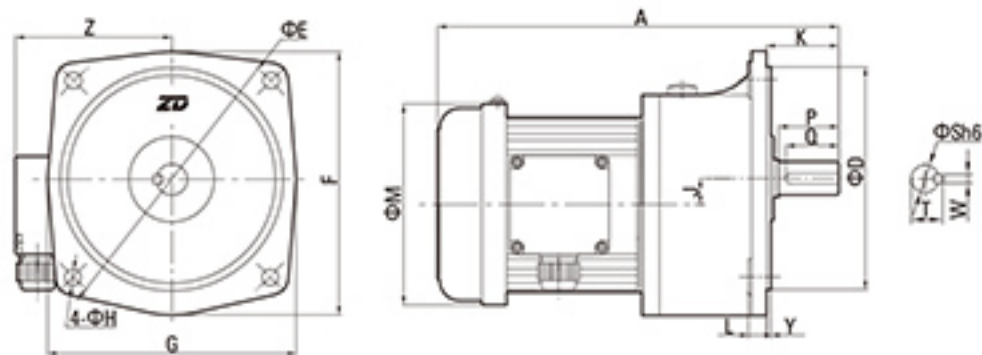

■ 高速比(1#+3#) High Ratio(1#+3#)

■ 卧式 Horizontal

■ 卧式 Horizontal

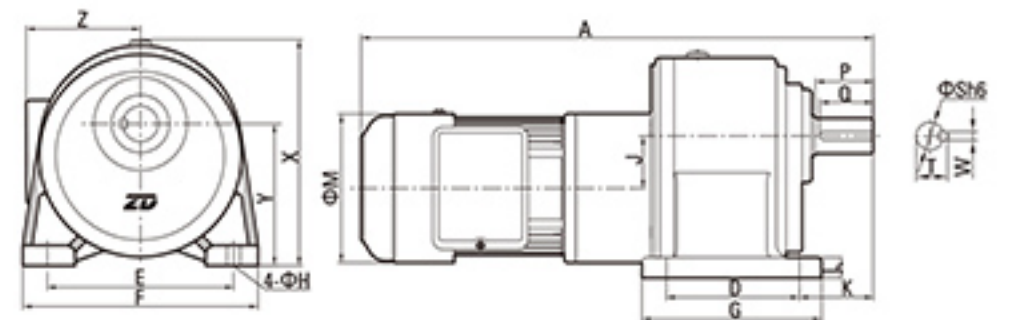
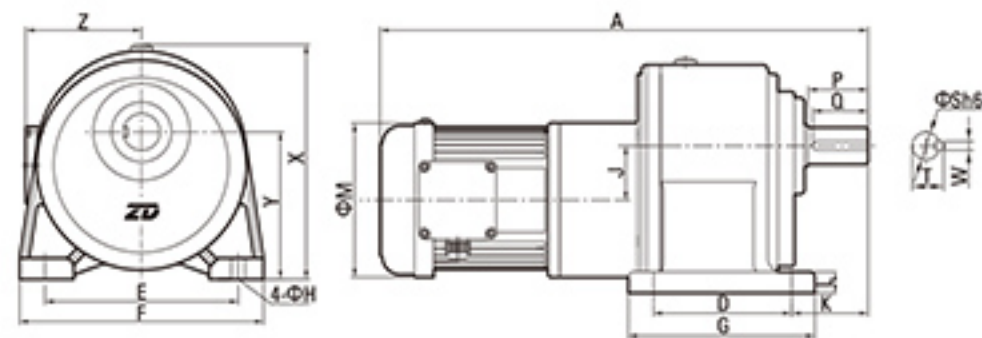

■ 立式 Vertical

■ 立式 Vertical

